

Technical Specification

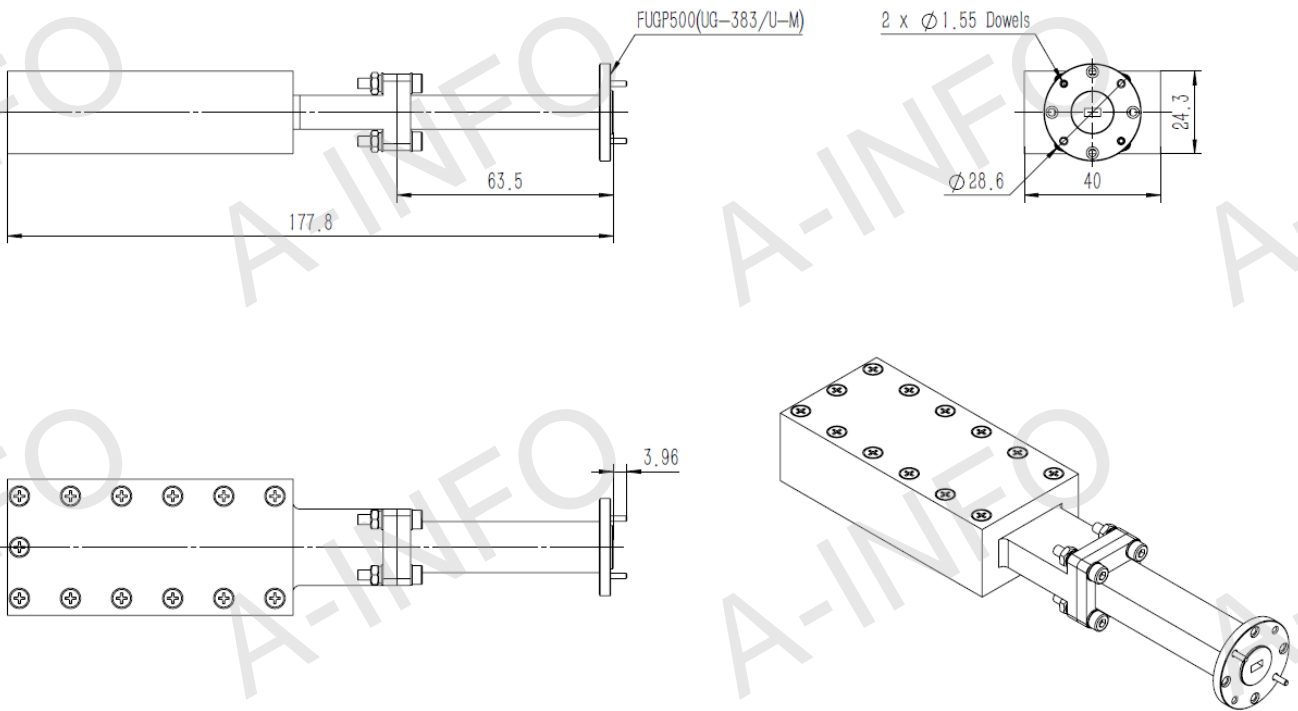

EIA WR	WR19
Frequency Range(GHz)	40.0-60.0
VSWR	1.2:1 Max.
Average Power(W)	45 CW
Peak Power(KW)	25
Flange	FUGP500(UG-383/U-M)
Material	Al
Size(mm) LxBxC	177.8 x 40 x 28.6
Net Weight(Kg)	0.35 Around

Outline Drawing (Size: mm)



Flange Drawing (Size: mm)

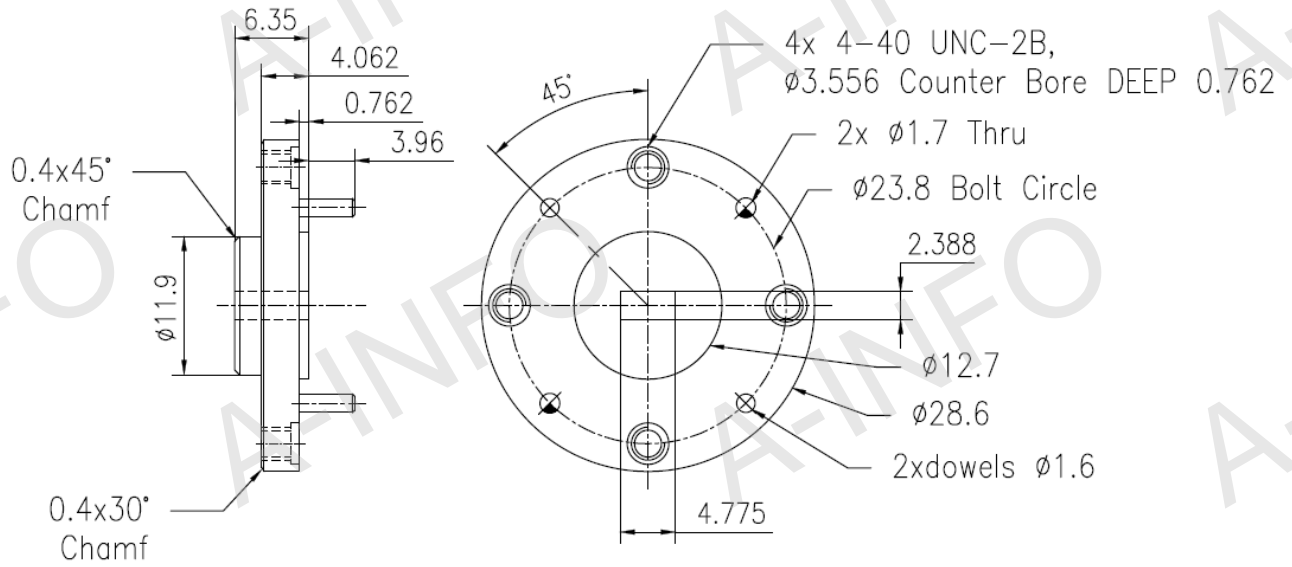

FUGP500
(equivalent to UG-383/U-M)

Test Results

VSWR

