

Technical Specification

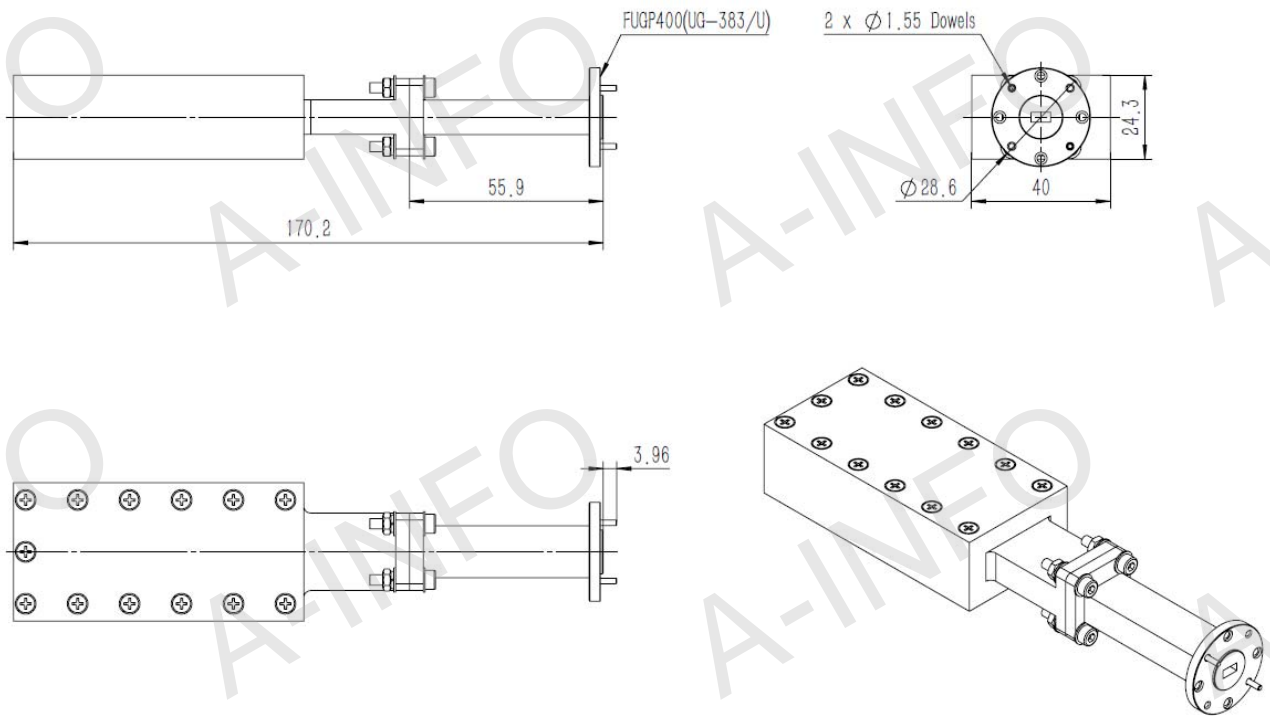

EIA WR	WR22
Frequency Range(GHz)	33.0-50.0
VSWR	1.2:1 Max.
Average Power(W)	50 CW
Peak Power(KW)	30
Flange	FUGP400(UG-383/U)
Material	Al
Size(mm) LxBxC	170.2 x 40 x 28.6
Net Weight(Kg)	0.35 Around

Outline Drawing (Size: mm)



Flange Drawing (Size: mm)

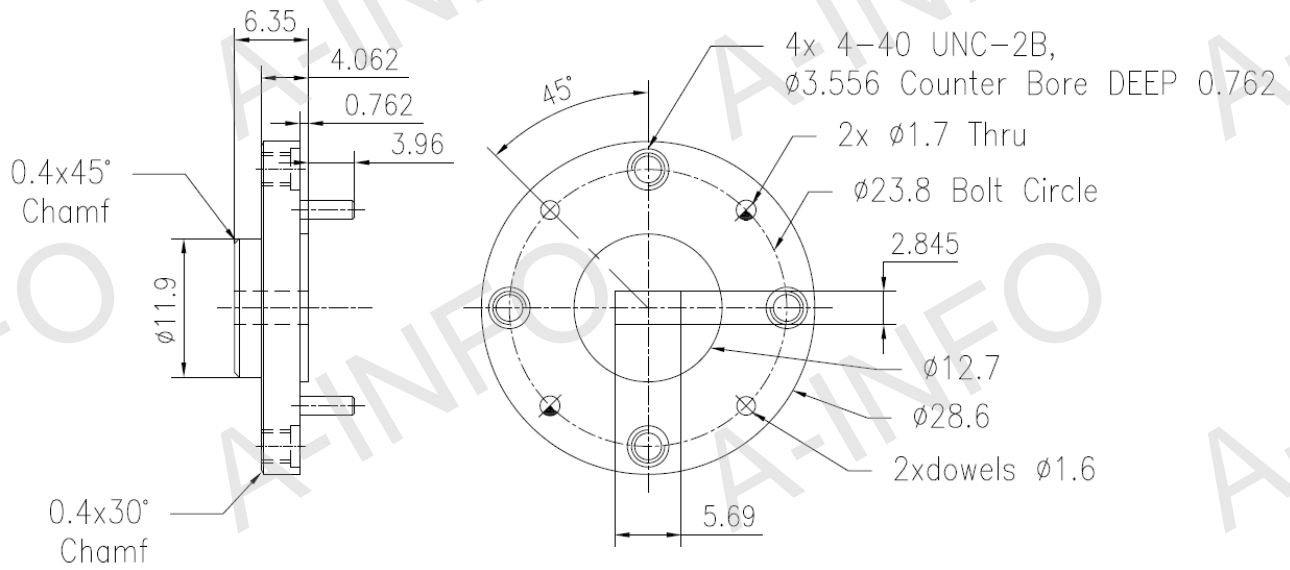

FUGP400
(equivalent to UG-383/U)

Test Results

VSWR

